

N-沟道功率 MOS 管/ N-CHANNEL POWER MOSFET

SIF33N10A

- 特点：导通电阻低 开关速度快 输入阻抗高 符合RoHS规范
- FEATURES: ■LOW ON-RESISTANCE ■FAST SWITCHING ■HIGH INPUT RESISTANCE ■RoHS COMPLIANT
- 应用：照明 不间断电源 LED 电视 消费类电器
- APPLICATION: ■LIGHTING ■UNINTERRUPTED POWER SUPPLY ■LED TV ■CONSUMER APPLIANCES

●最大额定值 (Tc=25°C)

●Absolute Maximum Ratings (Tc=25°C) TO-251T&252T

参数 PARAMETER	符号 SYMBOL	额定值 VALUE	单位 UNIT
漏-源电压 Drain-source Voltage	V _{DS}	100	V
-源电压 gate-source Voltage	V _{GS}	±30	V
漏极电流 Continuous Drain Current TC=25°C	I _D	33	A
漏极电流 Continuous Drain Current TC=100°C	I _D	16.5	A
最大脉冲电流 Drain Current — Pulsed ①	I _{DM}	132	A
耗散功率 Power Dissipation	P _{tot}	45	W
最高结温 Junction Temperature	T _J	150	°C
存储温度 Storage Temperature	T _{STG}	-55-150	°C
单脉冲雪崩能量 Single Pulse Avalanche Energy ②	E _{AS}	650	mJ

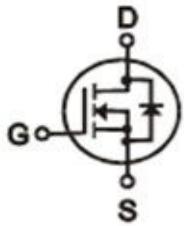

V_{DS}=100V
R_{DS(ON)}=26mΩ
I_D=33.0A



TO-251T (IPAK)

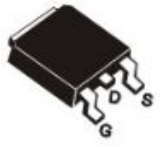

TO-252T (DPAK)

●电特性 (Tc=25°C)

●Electronic Characteristics (Tc=25°C)

参数 PARAMETER	符号 SYMBOL	测试条件 TEST CONDITION	最小值 MIN	典型值 TYP	最大值 MAX	单位 UNIT
漏-源击穿电压 Drain-source Breakdown Voltage	BV _{DSS}	V _{GS} =0V, I _D =250μA	100			V
击穿电压温度系数 Breakdown Voltage Temperature Coefficient	ΔBV _{DSS} /ΔT _J	I _D =250uA, Referenced to 25°C		0.2		V/°C
栅极开启电压 Gate Threshold Voltage	V _{GS(TH)}	V _{GS} =V _{DS} , I _D =250μA	2.0		4.0	V
漏-源漏电流 Drain-source Leakage Current	I _{DSS}	V _{DS} =100V, V _{GS} =0V, T _J =25°C			1	μA
		V _{DS} =100V, V _{GS} =0V, T _J =125°C			10	μA
跨导 Forward Transconductance	GFS	V _{DS} =10V, I _D =17A ③	8.0			S

●订单信息/ORDERING INFORMATION:

包装形式/PACKING	订货编码/ORDERING CODE	
	普通塑封料/ Normal Package Material	无卤塑封料/Halogen Free
TO-252T 或 251T 条管装/TUBE PACKING	SIF33N10A TO-251T-TU 或 SIF33N10A TO-252T-TU	SIF33N10A TO-251T-TU-HF 或 SIF33N10A TO-252T-TU-HF
TO-252T 编带装/TAPE & REEL PACKING	SIF33N10A TO-252T-TR	SIF33N10A TO-252T-TR-HF

N-沟道功率 MOS 管/ N-CHANNEL POWER MOSFET

SIF33N10A

参数 PARAMETER	符号 SYMBOL	测试条件 TEST CONDITION	最小值 MIN	典型值 TYP	最大值 MAX	单位 UNIT
栅极漏电流 Gate-body Leakage Current ($V_{DS} = 0$)	I_{GSS}	$V_{GS} = \pm 30V$			± 100	nA
漏-源导通电阻 Static Drain-source On Resistance	$R_{DS(ON)}$	$V_{GS} = 10V, I_D = 17A$ ③		26.0	35.0	m Ω
输入电容 Input Capacitance	C_{iss}	$V_{GS} = 0V, V_{DS} = 25V$ $F = 1.0MHz$		1380		pF
输出电容 Output Capacitance	C_{oss}			350		pF
输入电容 Miller Capacitance	C_{rss}			45		pF
关断延迟 Turn -Off Delay Time	$T_d(off)$	$V_{DD} = 50V, I_D = 33A$ $R_G = 3.5\Omega, R_D = 25\Omega$ ③		90		ns
栅极电荷 Total Gate Charge	Q_g	$I_D = 33A, V_{DS} = 80V$ $V_{GS} = 10V$ ③		28.5		nC
栅源电荷 Gate-to-Source Charge	Q_{gs}			7.5		nC
栅漏电荷 Gate-to-Drain Charge	Q_{gd}			11.0		nC
二极管正向电流 Continuous Diode Forward Current	I_S				33.0	A
二极管正向压降 Diode Forward Voltage	V_{SD}	$T_j = 25^\circ C, I_S = 33A$ $V_{GS} = 0V$ ③			1.45	V
反向恢复时间 Reverse Recovery Time	t_{rr}	$T_j = 25^\circ C, I_f = 33A$ $di/dt = 100A/\mu s$ ③			150	ns
反向恢复电荷 Reverse Recovery Charge	Q_{rr}			450		nC

●热特性

●Thermal Characteristics

参数 PARAMETER	符号 SYMBOL	最大值 MAX		单位 UNIT
		To-252T	To-251T	
热阻结-壳 Thermal Resistance Junction-case	R_{thJC}	2.78	2.78	$^\circ C/W$
热阻结-环境 Thermal Resistance Junction-ambient	R_{thJA}	62.5	62.5	$^\circ C/W$

注释(Notes):

- ① 脉冲宽度：以最高结温为限制
Repetitive rating: Pulse width limited by maximum junction temperature
- ② 初始结温=25 $^\circ C$, $V_{DD} = 50V$, $L = 1.5 mH$, $R_G = 25\Omega$, $I_{AS} = 30.0A$
Starting $T_j = 25^\circ C$, $V_{DD} = 50V$, $L = 1.5 mH$, $R_G = 25\Omega$, $I_{AS} = 30.0A$
- ③ 脉冲测试：脉冲宽度 $\leq 300\mu s$ ，占空比 $\leq 2\%$
Pulse Test : Pulse width $\leq 300\mu s$, Duty cycle $\leq 2\%$

N-沟道功率 MOS 管/ N-CHANNEL POWER MOSFET

SIF33N10A

● 特性曲线



图 1 输出特性曲线, Tc=25°C

Fig1 Typical Output Characteristics, Tc=25°C

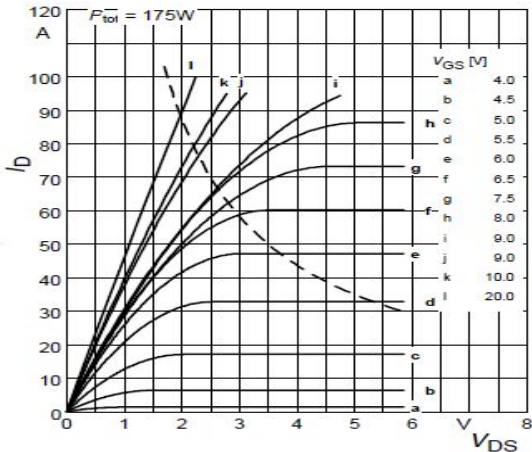

图 2 导通电阻与漏极电流和栅极电压曲线

Fig2 On-Resistance Vs.Drain Current and Gate Voltage

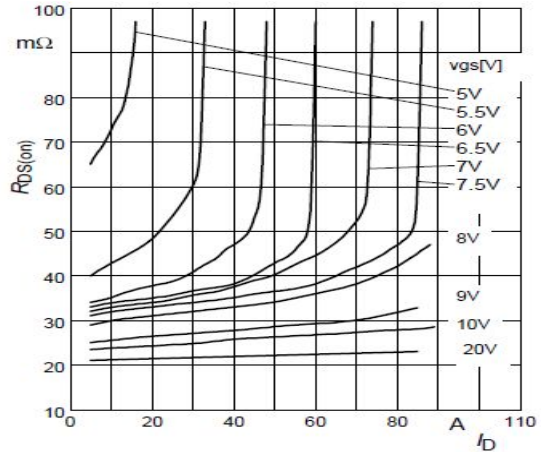

图 3 导通电阻与温度曲线

Fig3 Normalized On-Resistance Vs.Temperature

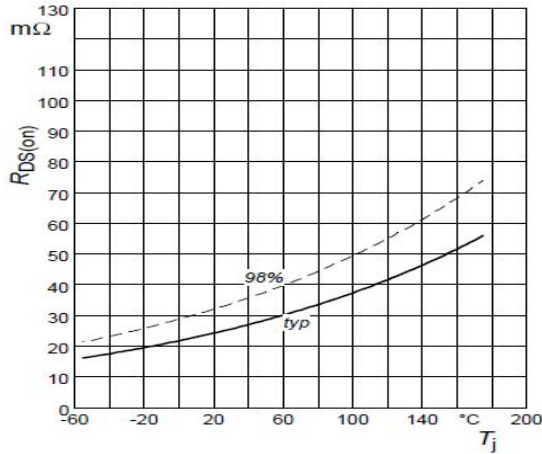

图 4 二极管正向电压曲线

Fig4 Typical Source-Drain Diode Forward Voltage

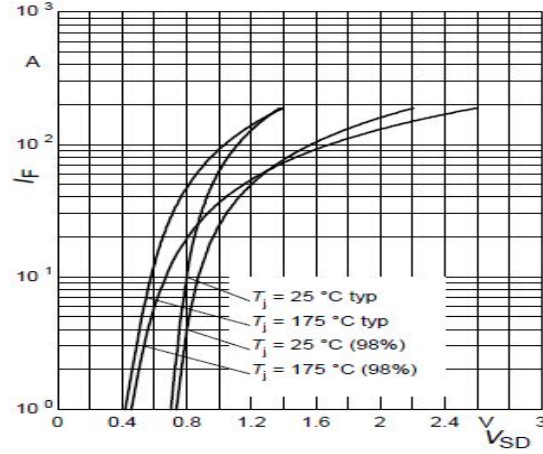

图 5 最大漏极电流与壳温曲线

Fig5 Maximum Drain Current Vs.Case Temperature

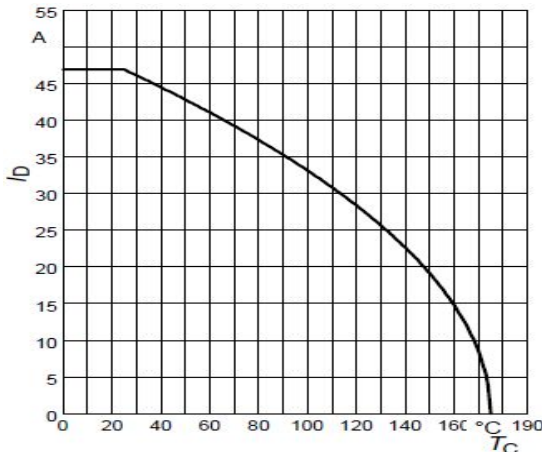

图 6 最大安全工作区曲线&TO-220

Fig6 Maximum Safe Operating Area&TO-220

TO-251T 封装机械尺寸

TO-251T (IPAK) MECHANICAL DATA

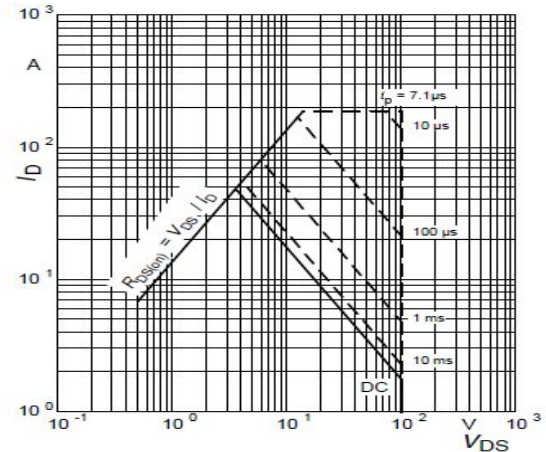
单位:毫米/UNIT: mm

符号/SYMBOL	最小值/min	典型值/nom	最大值/max
A	2.10		2.50
A ₁	0.95		1.30
B	0.80		1.25
b	0.50		0.80
b ₁	0.70		0.80
c	0.45		0.70
c ₁	0.45		0.70
D	6.35		6.80
D ₁	5.10		5.50
E	5.30		6.30
e	2.25	2.30	2.35
L	7.00		9.20
H	0.35		0.45
W1	0.30		0.50
W2	0.20		0.40

[S/L]

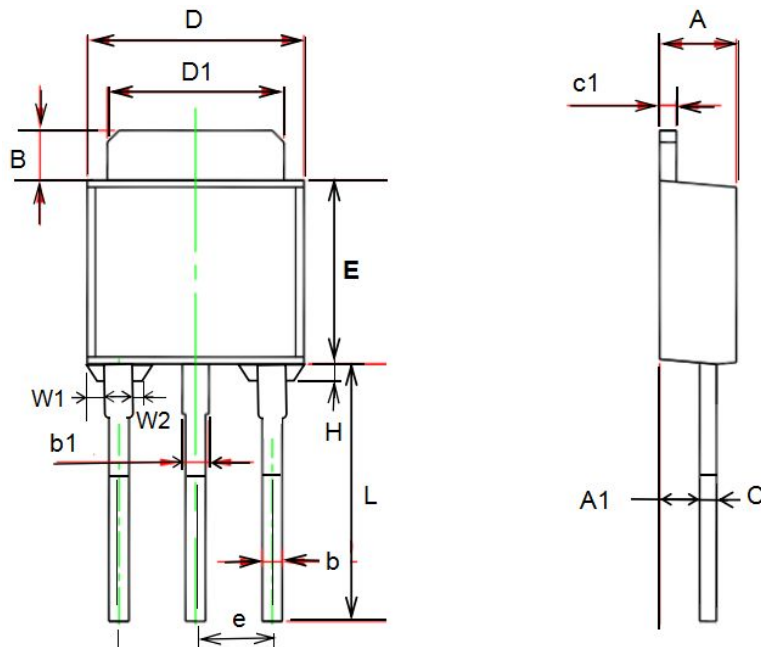

TO-252T 封装机械尺寸 TO-252T MECHANICAL DATA

单位:毫米/UNIT: mm

符号 SYMBOL	最小值 min	最大值 max	符号 SYMBOL	最小值 min	最大值 max
A	2.20	2.40	B	0.85	1.25
b	0.50	0.80	C	0.45	0.70
b1	0.45	0.70	D	6.30	6.70
D1	5.10	5.50	E	5.30	6.20
L1	9.20	10.60	F	0.50	0.90
L2	0.90	1.50	e1	2.25	2.35
L3	0.60	1.10	e2	4.50	4.70
			K	0.00	0.18

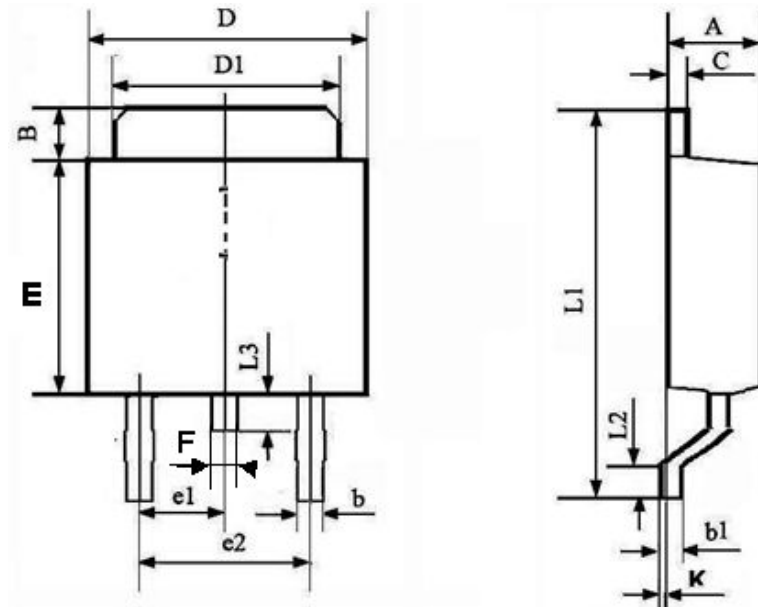

[LJ]

TO-252 编带规格尺寸 TO-252 TAPE AND REEL DATA

单位:毫米/UNIT: mm

符号 SYMBOL	最小值 min	典型值 nom	最大值 max	符号 SYMBOL	最小值 min	典型值 nom	最大值 max
A0	6.80	6.90	7.00	B0	10.40	10.50	10.60
K0	2.60	2.70	2.90	K1	2.40	2.50	2.60
F	7.40	7.50	7.60	K2	1.60	1.70	1.80
W	15.90	16.00	16.10	P1	7.90	8.00	8.10

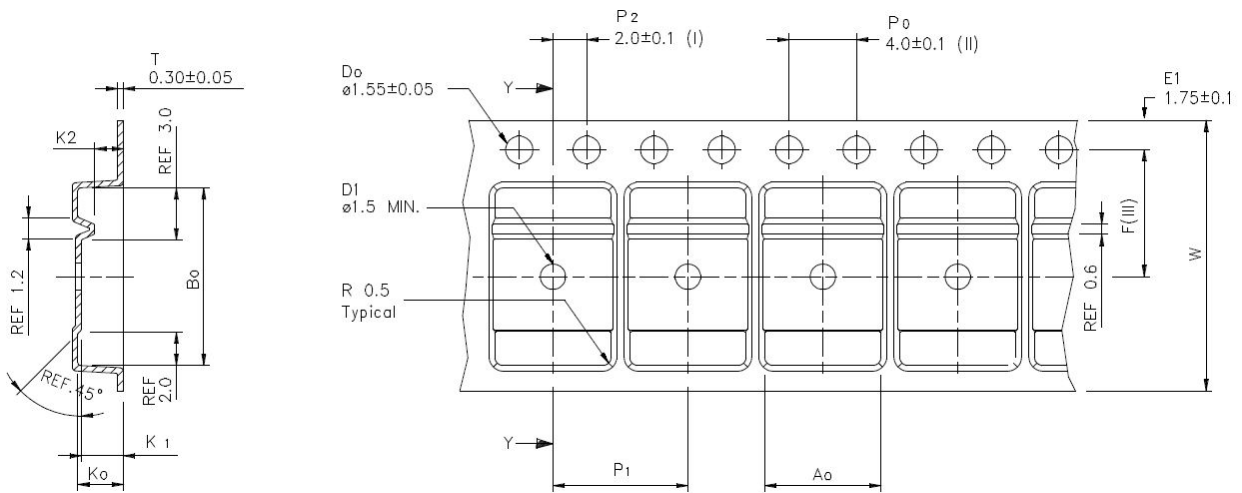

使用供带方向/USER DIRECTION OF FEED

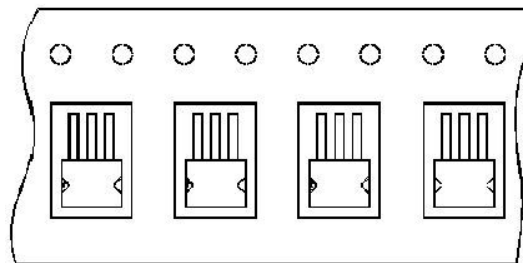

编带器件定位/UNIT ORIENTATION