

N-沟道功率 MOS 管/ N-CHANNEL POWER MOSFET

SIF20N50C

- 特点：导通电阻低 开关速度快 输入阻抗高 符合RoHS规范
- FEATURES: ■LOW ON-RESISTANCE ■FAST SWITCHING ■HIGH INPUT RESISTANCE ■RoHS COMPLIANT
- 应用：电子镇流器 电子变压器 开关电源
- APPLICATION: ■ELECTRONIC BALLAST■ELECTRONIC TRANSFORMER■SWITCH MODE POWER SUPPLY

●最大额定值 (Tc=25°C)

●Absolute Maximum Ratings (Tc=25°C) TO-3P

参数 PARAMETER	符号 SYMBOL	额定值 VALUE	单位 UNIT
漏-源电压 Drain-source Voltage	V _{DS}	500	V
栅-源电压 gate-source Voltage	V _{GS}	±30	V
漏极电流 Continuous Drain Current TC=25°C	I _D	20.0	A
漏极电流 Continuous Drain Current TC=100°C	I _D	15	A
最大脉冲电流 Drain Current – Pulsed ①	I _{DM}	80	A
耗散功率 Power Dissipation	P _{tot}	290	W
最高结温 Junction Temperature	T _J	150	°C
存储温度 Storage Temperature	T _{STG}	-55-150	°C
单脉冲雪崩能量 Single Pulse Avalanche Energy ②	E _{AS}	1100	mJ

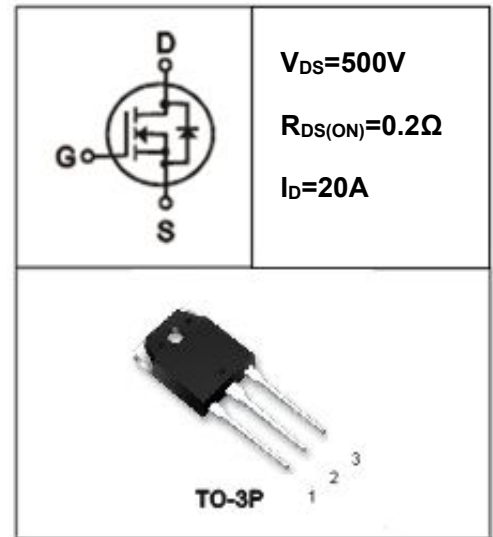

●电特性 (Tc=25°C)

●Electronic Characteristics (Tc=25°C)

参数 PARAMETER	符号 SYMBOL	测试条件 TEST CONDITION	最小值 MIN	典型值 TYP	最大值 MAX	单位 UNIT
漏-源击穿电压 Drain-source Breakdown Voltage	BV _{DSS}	V _{GS} =0V, I _D =250μA	500			V
击穿电压温度系数 Breakdown Voltage Temperature Coefficient	ΔBV _{DSS} / ΔT _J	I _D =250uA, Referenced to 25°C		0.6		V/°C
栅极开启电压 Gate Threshold Voltage	V _{GS(TH)}	V _{GS} =V _{DS} , I _D =250μA	2.0		5	V
漏-源漏电流 Drain-source Leakage Current	I _{DSS}	V _{DS} = 500V, V _{GS} = 0V, T _J = 25°C			1	μA
		V _{DS} = 400V, V _{GS} = 0V, T _J = 125°C			10	μA
跨导 Forward Transconductance	g _{fs}	V _{DS} = 40V, I _D = 12.0A ③		90		S

● 订单信息/ORDERING INFORMATION:

包装形式/PACKING	订货编码/ORDERING CODE	
	普通塑封料/ Normal Package Material	无卤塑封料/Halogen Free
TO-3P 条管装/TUBE PACKING	SIF20N50C TO-3P-TU	SIF20N50C TO-3P-TU-HF

N-沟道功率 MOS 管/ N-CHANNEL POWER MOSFET

SIF20N50C

参数 PARAMETER	符号 SYMBOL	测试条件 TEST CONDITION	最小值 MIN	典型值 TYP	最大值 MAX	单位 UNIT
栅极漏电流 Gate-body Leakage Current ($V_{DS} = 0$)	I_{GSS}	$V_{GS} = \pm 30V$			± 100	nA
漏-源导通电阻 Static Drain-source On Resistance	$R_{DS(ON)}$	$V_{GS} = 10V, I_D = 12.0A$ ③		0.2	0.25	Ω
输入电容 Input Capacitance	C_{iss}	$V_{GS} = 0V, V_{DS} = 25V$ $F = 1.0MHz$		3200		pF
关断延迟 Turn -Off Delay Time	$T_d(off)$	$V_{DD} = 250V, I_D = 20.0A$ $R_G = 25\Omega$ ③		200		ns
栅极电荷 Total Gate Charge	Q_g	$I_D = 20.0A, V_{DS} = 400V$ $V_{GS} = 10V$ ③		62.5		nC
栅源电荷 Gate-to-Source Charge	Q_{gs}			16.5		nC
栅漏电荷 Gate-to-Drain Charge	Q_{gd}			21.5		nC
二极管正向电流 Continuous Diode Forward Current	I_S				24.0	A
二极管正向压降 Diode Forward Voltage	V_{SD}	$T_j = 25^\circ C, I_S = 20.0A$ $V_{GS} = 0V$ ③			1.4	V
反向恢复时间 Reverse Recovery Time	t_{rr}	$T_j = 25^\circ C, I_f = 20.0A$ $di/dt = 100A/\mu s$ ③		400		ns
反向恢复电荷 Reverse Recovery Charge	Q_{rr}			4.2		μC

●热特性

●Thermal Characteristics

参数 PARAMETER	符号 SYMBOL	最小值 MIN	典型值 TYP	最大值 MAX	单位 UNIT
热阻结-壳 Thermal Resistance Junction-case	R_{thJC}			0.43	$^\circ C/W$
热阻结-环境 Thermal Resistance Junction-ambient	R_{thJA}			40	$^\circ C/W$

注释(Notes):

- ① 脉冲宽度：以最高结温为限制
Repetitive rating: Pulse width limited by maximum junction temperature
- ② 初始结温=25 $^\circ C$, $V_{DD} = 50V$, $L = 3.4mH$, $R_G = 25\Omega$, $I_{AS} = 24.0A$
Starting $T_j = 25^\circ C$, $V_{DD} = 50V$, $L = 3.4mH$, $R_G = 25\Omega$, $I_{AS} = 24.0A$
- ③ 脉冲测试：脉冲宽度 $\leq 300\mu s$ ，占空比 $\leq 2\%$
Pulse Test : Pulse width $\leq 300\mu s$, Duty cycle $\leq 2\%$

N-沟道功率 MOS 管/ N-CHANNEL POWER MOSFET

SIF20N50C

● 特性曲线



图 1 输出特性曲线, Tc=25°C

Fig1 Typical Output Characteristics, Tc=25°C

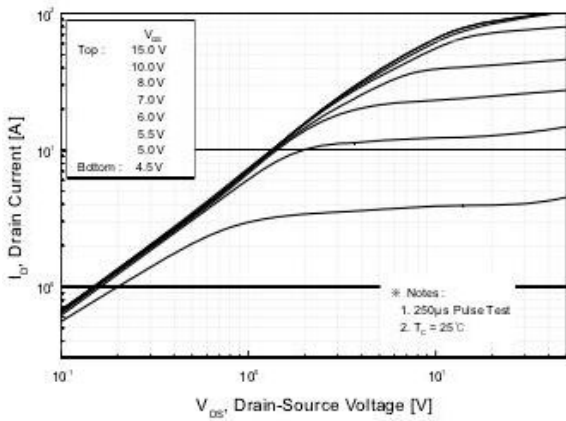

图 2 转移特性

Fig2 Typical Transfer Characteristics

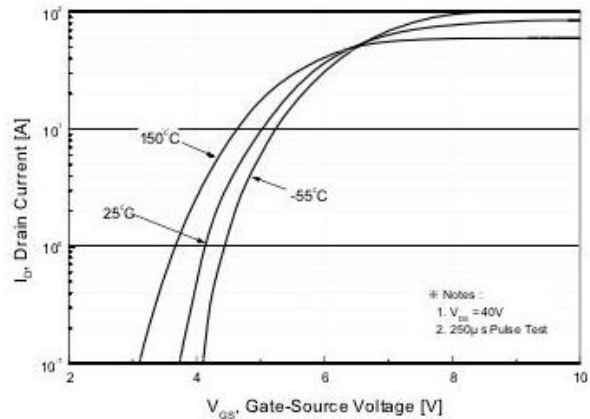

图 3 归一化导通电阻与温度曲线

Fig3 Normalized Resistance Vs. Temperature

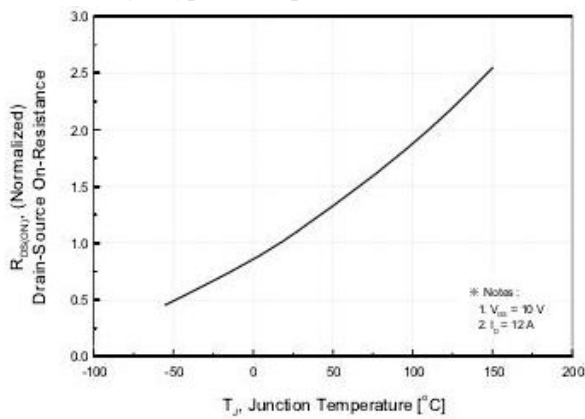

图 4 二极管正向电压曲线

Fig4 Typical Source-Drain Diode Forward Voltage

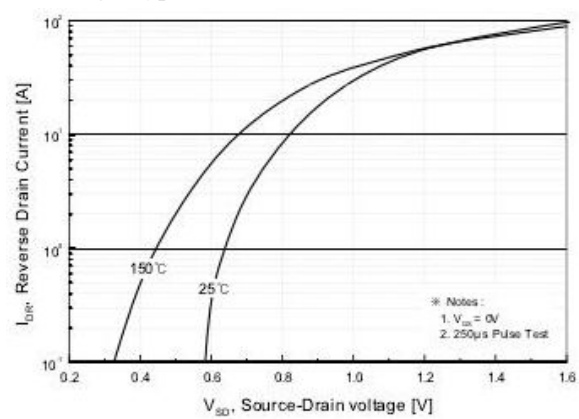

图 5 最大漏极电流与壳温曲线

Fig5 Maximum Drain Current Vs. Case Temperature

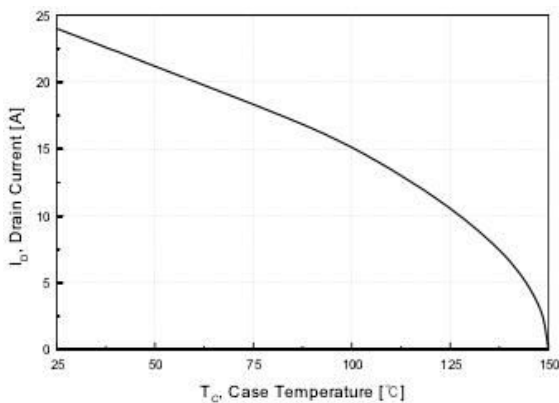

图 6 最大安全工作区曲线

Fig6 Maximum Safe Operating Area



图 7 导通电阻与漏极电流的归一化曲线
Fig7 On-Resistance Variation Vs Drain Current

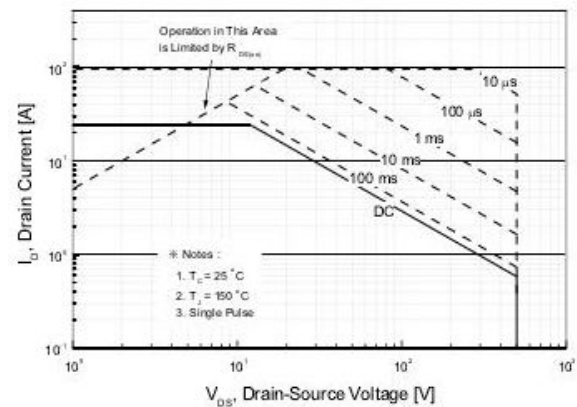

图 8 电容特性
Fig8 Capacitance Characteristics

TO-3P 封装机械尺寸 TO-3P MECHANICAL DATA

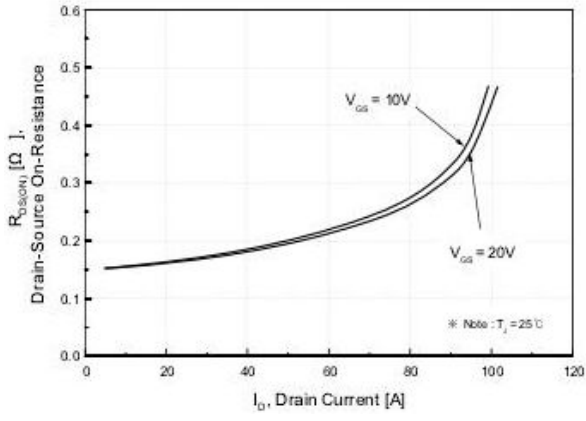
单位：毫米/UNIT: mm

符号 SYMBOL	最小值 min	典型值 nom	最大值 max	符号 SYMBOL	最小值 min	典型值 nom	最大值 max
A	4.50		5.00	E	15.40		15.80
A1	1.45	1.50	1.65	E1		13.60	
A2	1.20	1.40	1.60	E2		9.60	
b	0.80	1.00	1.20	e	5.15	5.45	5.75
b1	1.80		2.20	L	19.50	20	20.50
b2	2.80		3.20	L1	2.90	3.50	
C	0.55	0.60	0.75	P	3.10	3.30	3.50
D	19.70	19.90	20.10	Q		5.00	
D1		13.90		Q1		3.80	

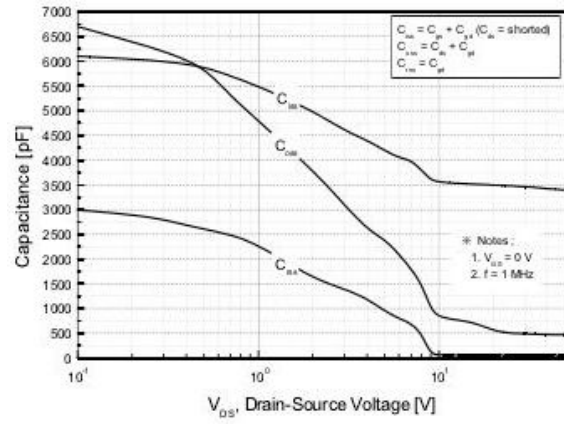