

N-沟道功率 MOS 管/ N-CHANNEL POWER MOSFET

SIF11N50E

●特点：热阻低 开关速度快 输入阻抗高 符合RoHS规范

●FEATURES: ■LOW THERMAL RESISTANCE ■FAST SWITCHING ■HIGH INPUT RESISTANCE
■RoHS COMPLIANT

●应用：电子镇流器 电子变压器 开关电源

●APPLICATION: ■ELECTRONIC BALLAST ■ELECTRONIC TRANSFORMER ■SWITCH MODE POWER SUPPLY

●最大额定值 (TC=25°C)

●Absolute Maximum Ratings (Tc=25°C) **TO-220/220FP(L)**

参数 PARAMETER	符号 SYMBOL	额定值 VALUE	单位 UNIT
漏-源电压 Drain-source Voltage	V _{DS}	500	V
栅-源电压 gate-source Voltage	V _{GS}	±30	V
漏极电流 Continuous Drain Current TC=25°C	I _D	11*	A
漏极电流 Continuous Drain Current TC=100°C	I _D	6.5*	A
最大脉冲电流 Drain Current - Pulsed ①	I _{DM}	44*	A
耗散功率 Power Dissipation	P _D	TO-220:170	W
		TO-220FP(L):56	
最高结温 Junction Temperature	T _j	150	°C
存储温度 Storage Temperature	T _{STG}	-55-150	°C
单脉冲雪崩能量 Single Pulse Avalanche Energy②	E _{AS}	500	mJ

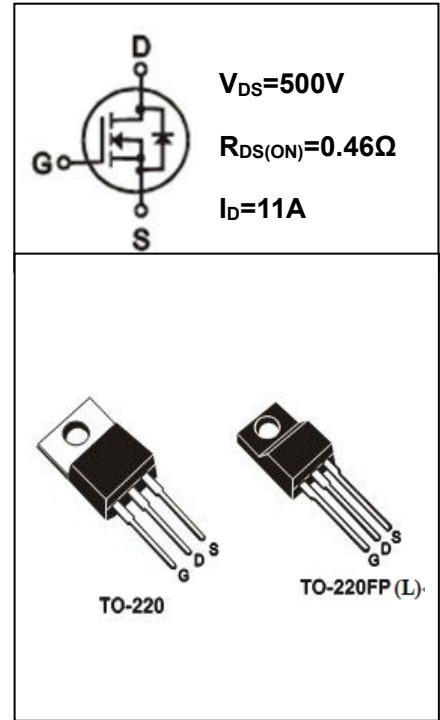

*漏极电流由最高结温限制

*Drain current limited by maximum junction temperature

●电特性 (Tc=25°C)

●Electronic Characteristics (Tc=25°C)

参数 PARAMETER	符号 SYMBOL	测试条件 TEST CONDITION	最小值 MIN	典型值 TYP	最大值 MAX	单位 UNIT
漏-源击穿电压 Drain-source Breakdown Voltage	BV _{DSS}	V _{GS} =0V, I _D =250μA	500			V
击穿电压温度系数 Breakdown Voltage Temperature Coefficient	ΔBV _{DSS} / ΔT _j	I _D =250uA, Referenced to 25°C		0.7		V/°C
栅极开启电压 Gate Threshold Voltage	V _{GS(TH)}	V _{GS} =V _{DS} , I _D =250μA	2.0		4.0	V
漏-源漏电流 Drain-source Leakage Current	I _{DSS}	V _{DS} =500V, V _{GS} =0V, T _j =25°C			1	μA
		V _{DS} =400V, V _{GS} =0V, T _j =125°C			10	μA
跨导 Forward Transconductance	g _{fs}	V _{DS} =40V, I _D =5.5A ③		8		S

●订单信息/ORDERING INFORMATION:

包装形式/PACKING	订货编码/ORDERING CODE	
	普通塑封料/ Normal Package Material	无卤塑封料/Halogen Free
TO-220 条管装/TUBE PACKING	SIF11N50E TO-220-TU	SIF11N50E TO-220-TU-HF
TO-220FP(L) 条管装/TUBE PACKING	SIF11N50E TO-220FP(L) -TU	SIF11N50E TO-220FP(L) -TU-HF

N-沟道功率 MOS 管/ N-CHANNEL POWER MOSFET

SIF11N50E

参数 PARAMETER	符号 SYMBOL	测试条件 TEST CONDITION	最小值 MIN	典型值 TYP	最大值 MAX	单位 UNIT
栅极漏电流 Gate-body Leakage Current ($V_{DS} = 0$)	I_{GSS}	$V_{GS} = \pm 20V$			± 100	nA
漏-源导通电阻 Static Drain-source On Resistance	$R_{DS(ON)}$	$V_{GS} = 10V, I_D = 5.5A$ ③		0.46	0.65	Ω
输入电容 Input Capacitance	C_{iss}	$V_{GS} = 0V, V_{DS} = 25V$ $F = 1.0MHz$		1550		pF
输出电容 Output Capacitance	C_{oss}			139		
反馈电容 Feedback Capacitance	C_{rss}			13		
关断延迟 Turn -Off Delay Time	$T_d(off)$	$V_{DD} = 250V, I_D = 11A$ $R_G = 25\Omega$ ③		144		ns
栅极电荷 Total Gate Charge	Q_g	$I_D = 11A, V_{DS} = 400V$ $V_{GS} = 10V$ ③		31		nC
栅源电荷 Gate-to-Source Charge	Q_{gs}			8.0		nC
栅漏电荷 Gate-to-Drain Charge	Q_{gd}			10.3		nC
二极管正向电流 Continuous Diode Forward Current	I_s				11	A
二极管正向压降 Diode Forward Voltage	V_{SD}	$T_j = 25^\circ C, I_s = 11A$ $V_{GS} = 0V$ ③			1.4	V
反向恢复时间 Reverse Recovery Time	t_{rr}	$T_j = 25^\circ C, I_f = 11A$ $di/dt = 100A/\mu s$ ③		420		ns
反向恢复电荷 Reverse Recovery Charge	Q_{rr}			4.2		μC

●热特性

●Thermal Characteristics

参数 PARAMETER	符号 SYMBOL	最大值 MAX		单位 UNIT
		TO-220	TO-220FP(L)	
热阻结-壳 Thermal Resistance Junction-case	R_{thJC}	0.74	2.23	$^\circ C/W$
热阻结-环境 Thermal Resistance Junction-ambient	R_{thJA}	62.5	62.5	$^\circ C/W$

注释(Notes):

- ① 脉冲宽度：以最高节温为限制
Repetitive rating: Pulse width limited by maximum junction temperature
- ② Starting $T_j = 25^\circ C, V_{DD} = 50V, L = 5mH, R_G = 25\Omega, I_{AS} = 11A$
- ③ 脉冲测试：脉冲宽度 $\leq 300\mu s$ ，占空比 $\leq 2\%$
Pulse Test : Pulse width $\leq 300\mu s$, Duty cycle $\leq 2\%$

N-沟道功率 MOS 管/ N-CHANNEL POWER MOSFET

SIF11N50E

● 特性曲线



图 1 输出特性曲线, Tc=25°C
Fig1 Typical Output Characteristics, Tc=25°C



图 2 导通电阻与漏极电流和栅极电压曲线
Fig2 On-Resistance Vs.Drain Current and Gate Voltage

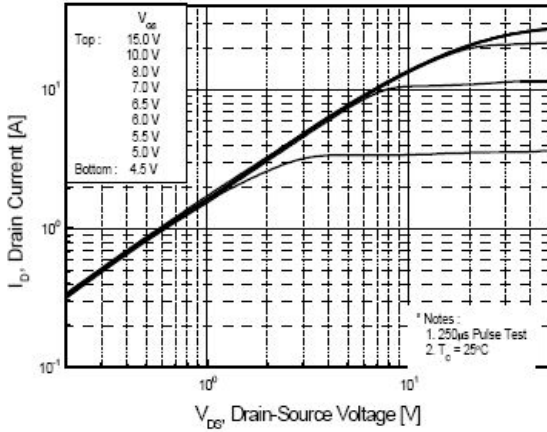

图 3 导通电阻与温度曲线
Fig3 Normalized On-Resistance Vs.Temperature

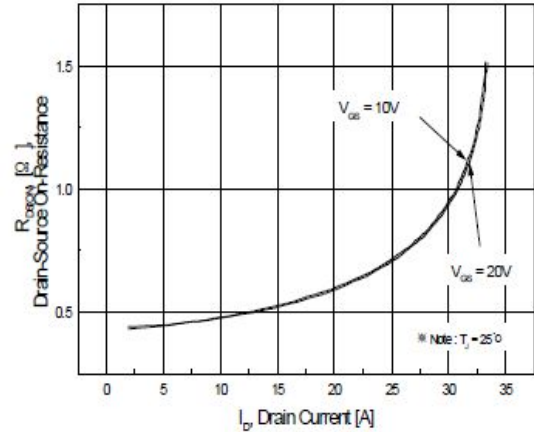

图 4 二极管正向电压曲线
Fig4 Typical Source-Drain Diode Forward Voltage

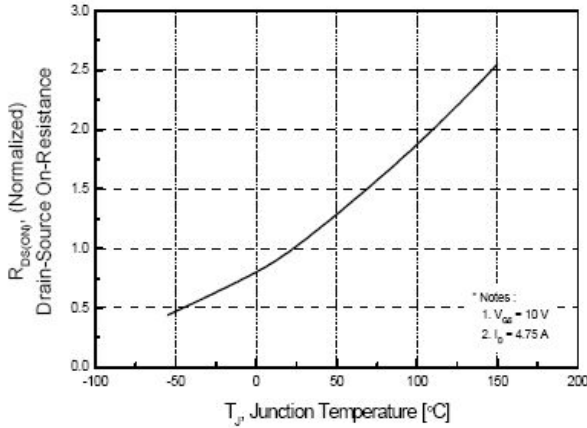

图 5 最大漏极电流与壳温曲线
Fig5 Maximum Drain Current Vs.Case Temperature

N-沟道功率 MOS 管/ N-CHANNEL POWER MOSFET

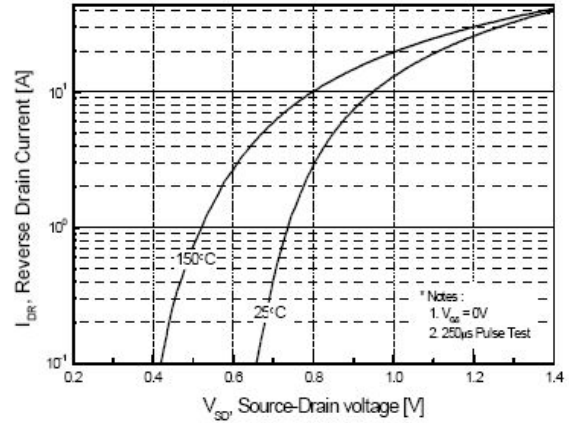
SIF11N50E

● 特性曲线

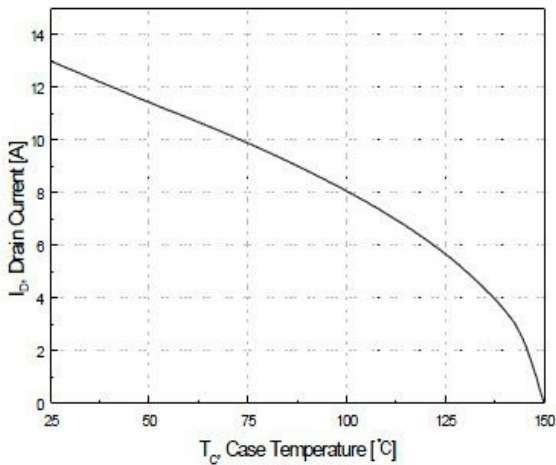

图 6-1 SIF11N50E(TO-220)
最大安全工作区曲线
Fig6-1 Maximum Safe Operating Area



图 6-2 SIF11N50E(TO-220FP(L))
最大安全工作区曲线
Fig6-2 Maximum Safe Operating Area

TO-220 封装机械尺寸 TO-220 MECHANICAL DATA

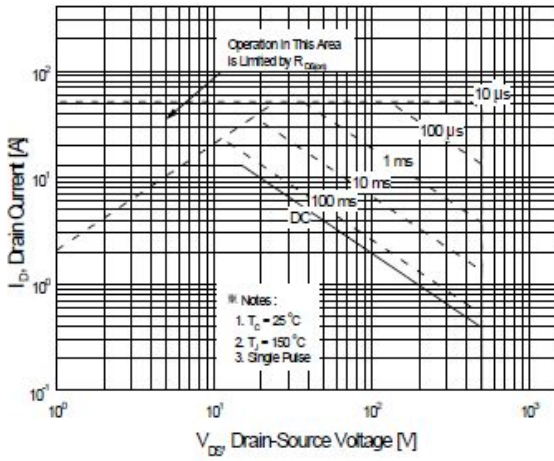
单位：毫米/UNIT: mm

符号 SYMBOL	最小值 min	典型值 nom	最大值 max	符号 SYMBOL	最小值 min	典型值 nom	最大值 max
A	4.00		4.80	E	9.90		10.70
B	1.20		1.50	e		2.54	
B1	1.00		1.40	F	1.10		1.45
b1	0.65		1.00	L	12.50		14.50
c	0.35		0.75	L1	3.00	3.50	4.00
D	15.00		16.50	Q	2.50		3.00
D1	5.90		6.90	Q1	2.00		3.00
				φP	3.60		3.90

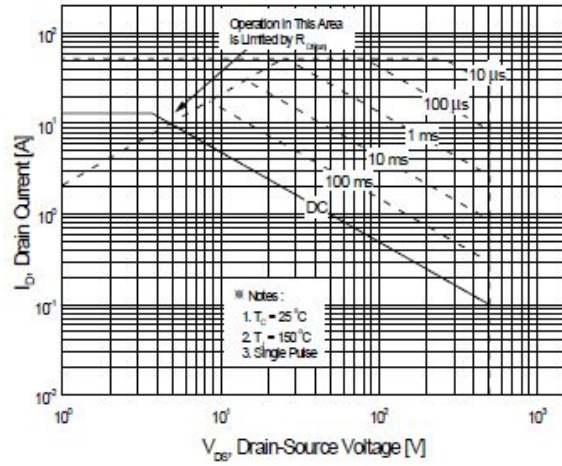
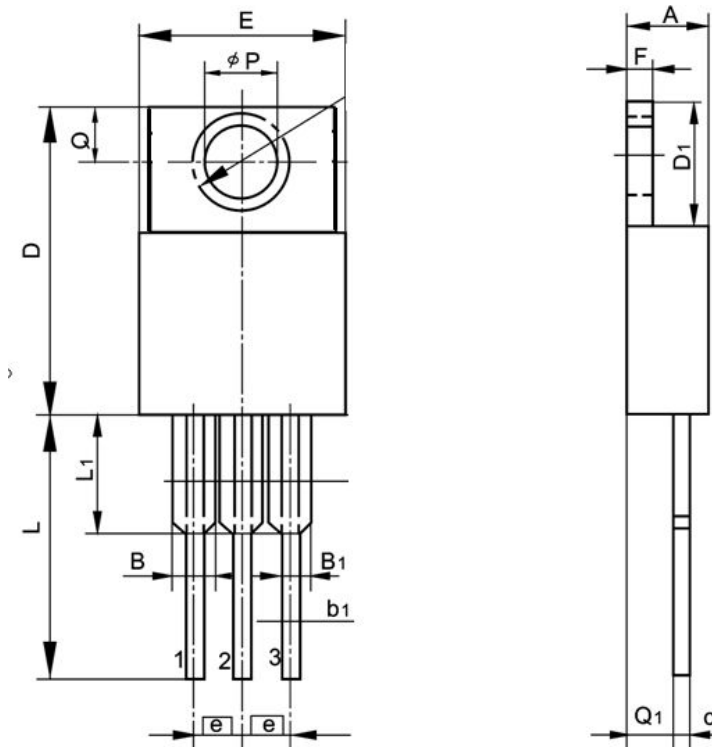

TO-220FP 封装机械尺寸 TO-220FP MECHANICAL DATA

单位:毫米/UNIT: mm

符号 SYMBOL	最小值 min	典型值 nom	最大值 max	符号 SYMBOL	最小值 min	典型值 nom	最大值 max
A	4.40		4.95	E	9.60		10.30
A ₁	2.30		2.90	e		2.54	
b	0.70		0.90	L	12.40		14.00
b ₁	1.18		1.45	L₂	2.30		2.60
c	0.40		0.70	L ₃	3.00		4.00
D	14.50		17.00	øp	3.00		3.50
D1	6.10		9.00	Q	2.30		2.80

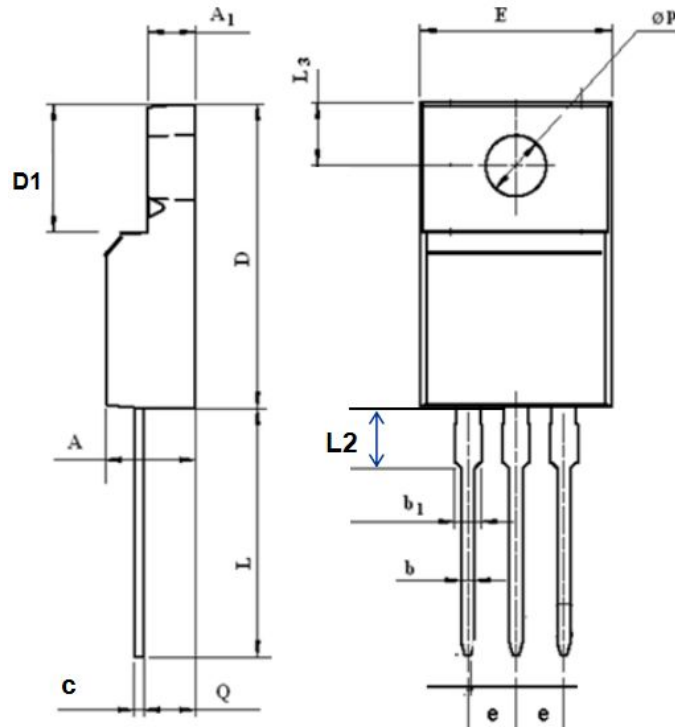

TO-220FPL 封装机械尺寸 TO-220FPL MECHANICAL DATA

单位:毫米/UNIT: mm

符号 SYMBOL	最小值 min	典型值 nom	最大值 max	符号 SYMBOL	最小值 min	典型值 nom	最大值 max
A	9.90		10.36	a	1.08		1.48
B	15.40		16.40	a1	0.70		0.90
B1	3.05		3.55	E	2.34		2.75
C	4.40		5.00	C1	2.25		2.85
c	0.40		0.60	C2	2.45		3.05
b	12.40		13.50	R	2.90		3.35
b1	2.90		3.90				Ⓛ

